

Landmark 365 User Guide – Mid 2017



Photo by Paul Townsend

Landmark 365 User Guide – Mid 2017

This guide is intended to assist Heartland Landmark 365 owners by augmenting the information found in the Heartland Landmark Manual.

Note that as model years change, Heartland introduces changes to the product. Changes may also be made mid-year. As a result, it's impossible to stay up-to-date for very long in a document like this. Nevertheless, the information here may prove helpful. Check the date of the document in the footnote. If the document is more than 1 year old, some information may be dated.

Important Notices

Who created this document?

This document has been created by Heartland Owners independently of the Heartland RV Company, and is posted to the Heartland Owners Forum, by owners, as a service to the entire owner community.

Errors and Omissions

Because the authors are Heartland owners, not engineers or service technicians, it's possible that this document could contain errors or omissions. Readers are advised to also review the manufacturers' product documentation for more complete information and guidance.

Additional Resources

The heartlandowners.org website has a collection of owner-written user guides, including information on water systems, heating and cooling, winterizing, residential refrigerator, water heater and other topics. This information is available at <http://manuals.heartlandowners.org/?man=User%20Guides>

Limitations on Using this Document

- This document may not be modified or sold.
- It may not be posted on the internet without permission.
- Other websites may link to the page from which the document may be downloaded, but may not link directly to the document without permission (search engines excluded).

Contact Information

Questions and comments may be directed to manuals@heartlandowners.org

Landmark 365 User Guide – Mid 2017

Table of Contents

Landmark Evolution to the Landmark Three Sixty Five	7
Introduction to Landmark 365 Features	7
Control Panel.....	7
Slide Operation	8
Exterior Lights	8
Flood / Scare Lights / Porch Light / Entry Light.....	8
Step Light	8
Interior Lights.....	9
Night Lights	9
Welcome Back Light.....	9
M-Plex Master Off Switch	9
Tank Gauges.....	10
Water Heater Electric.....	10
Checking for water in the water heater.....	11
Secondary Switch	11
Water Heater Anode Rod.....	11
Water Heater Usage Guide	12
Water Heater 12 Volt / Propane Operation.....	12
Yeti Package - Tank Heaters and Heat Tape	12
Ceiling Fan.....	13
Miscellaneous Controls.....	13
Water Pump Switch	13
Awning Switches	14
Awning Receptacle Switch	15
Inverter Remote Switch	15
Inverter Status Indicator Light Modification.....	15
Pass-thru Storage Lights and Front Storage Compartment Light	16
Appliances.....	16

Cooktop.....	16
Residential Refrigerator	16
Refrigerator Water Feed Line Cutoff Valve.....	16
Overview of electrical and inverter.....	17
Refrigerator Outside Access Panel.....	18
Microwave/Convection Oven	18
Vent.....	18
General Usage Notes	19
Washer/Dryer	19
Dishwasher.....	20
Winterizing the Dishwasher	20
Plumbing	21
Universal Docking Center (UDC)	21
Anderson 4-way valve.....	21
Black Tank Flush Connection(s).....	22
Safe Practices	23
Tank Valve Handles	24
Water Filter	26
Water Filter Winterization	26
Initial Installation	26
Tips When Changing the Filter Element.....	26
Water Pump.....	27
Fresh Tank Fill	27
Fresh Tank Drain	28
Filling the Fresh Tank From a Water Container	28
Low Point Drains	28
Studor Air Admittance Valves	28
Heating and Cooling.....	29
Furnace	29
Furnace Air Return and Floor Registers	30
Air Conditioner Runs When Furnace Runs.....	30
Air Conditioning	30

Air Conditioner Heat Pump Option	30
Cleaning return filters	31
What happens when available power is not enough	32
12V DC Electrical	32
Fuse Box	32
Checking for Blown Fuses	33
Batteries	33
Battery Cutoff Switches	33
Keeping Batteries Charged While Storing the Trailer	34
Using an On-board Generator to Charge Batteries While in Storage	34
Restarting the Residential Refrigerator Power System	34
Power Converter	35
Buss Bar and 12V Mini-Circuit Breakers	35
Hydraulics Pump Circuit Breaker	37
Intermittent Operation of Leveling System or Slide outs	37
Differences From These Pictures	37
Power to Breakaway Switch and Generator Start	38
Residential Refrigerator Inverter	38
120V AC Electrical	39
Circuit Breaker Panel	39
Generator Prep Automatic Transfer Switch and Surge Protector	40
Built-in Surge Protector	41
Residential Refrigerator Automatic Transfer Switch	41
GFCI Outlet	42
Surge Protection & Electrical Management Systems	42
Power Control System	43
Description of Operation	43
Reading the Precision Circuits Display	44
Prioritization of Load Shedding	45
Line Status	45
KIB Multi-plex Control System	45
Entertainment Center	46

Watching Cable TV 46

- Signal booster 46
- Cable TV Set Top Boxes 47

Watching Over-the-Air Antenna TV 48

- Operating the antenna pointer 48
- TV Menu Settings 48

Satellite TV 49

- External Connections 49
- Internal Connections 50
- Rooftop Mount 51

Sound Bar and Subwoofer 51

Landing Gear and Leveling System 51

- Control Panel Operation 51
- Manual Leveling 52
- If The Wheels are Lifted Off the Ground..... 52
- Zero Level Calibration 53
- Manual Pump Operation 53

Revision History 54

Landmark 365 User Guide – Mid 2017

Landmark Evolution to the Landmark Three Sixty Five

Heartland RV's first product was the 2005 model year Landmark, released in mid-2004. Since then, Landmark has gone through many changes. In mid-2014, Heartland re-launched the Landmark as the Landmark 365 product. Landmark 365 was designed with the full-timer and any-timer RVer in mind.

While some aspects of this guide would apply to all Landmarks, many items covered are Landmark 365 specific.

This update to the Landmark 365 User Guide covers changes introduced in late 2016 for the mid-year 2017 models.

Introduction to Landmark 365 Features

There's a lot to cover in a Landmark 365, but the Control Panel is central to using the coach.

Control Panel

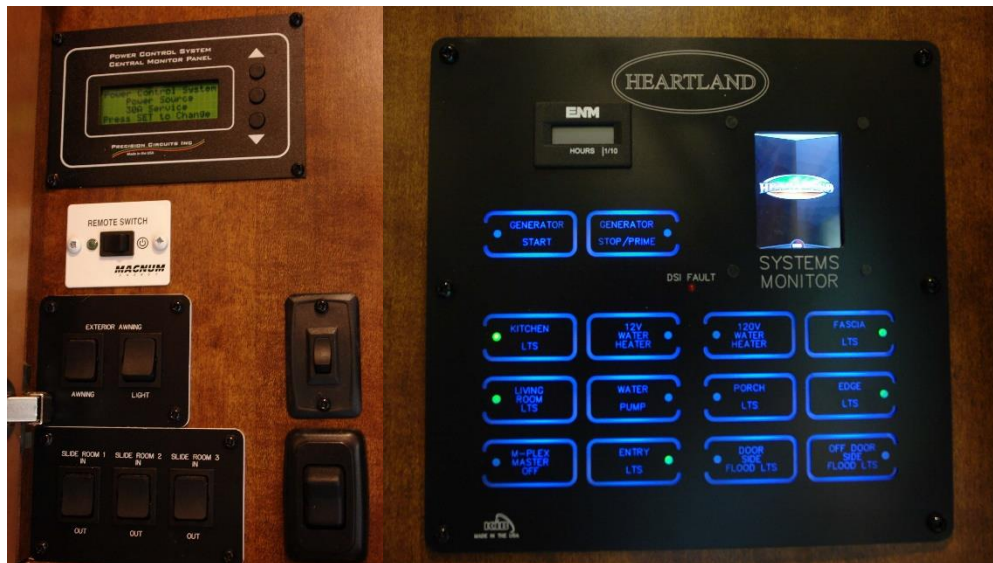

Most controls for the Landmark 365 are grouped together and are labeled clearly. Additional explanation follows on several controls.

Slide Operation

Landmarks have individual controls allowing you to operate each slide independently of the others. This allows you to open and close the slides in the sequence that best fits your needs. For example, at roadside rest stops, it's possible to extend the kitchen slide by itself to prepare lunch or grab a snack. Note that it's a good idea to let go of the rocker switch as soon as the slide reaches full extension or retraction. If you don't, the pump will continue to run under a higher than normal load.



Slide Room Controls

Exterior Lights

Flood / Scare Lights / Porch Light / Entry Light

Flood lights, sometimes known as “scare” lights, are mounted near the roof on each side. On the bottom right-hand side of the panel there are individual switches for the light on each side. There's also a switch for the porch light located over the outside steps, and for the entry light, located in the ceiling, just as you walk into the coach. The entry light is also used by the “Welcome Back Feature” which is explained more fully later in this document.

Step Light

There is a light located below the entry door, behind the steps, to help illuminate the steps at night. The switch is located in the control panel, but is not typically marked. Location of the switch in the control panel area will vary depending on floor plan.

Interior Lights

The “lounge”, “kitchen” and “ceiling” ceiling lights on the Landmark use extremely low power/low heat LED fixtures. This reduces power consumption when running on battery power and reduces heat load when running the air conditioning. Each has its own switch on the control panel. Additional redundant convenience switches are located near the lights.

Night Lights

To help find your way to the bathroom or kitchen at night, several floor-level night lights can be turned on with a single switch. There’s a switch at the entrance to the bedroom, and another near the stairs. The two switches operate in a 3-way configuration where either switch will operate all the lights.

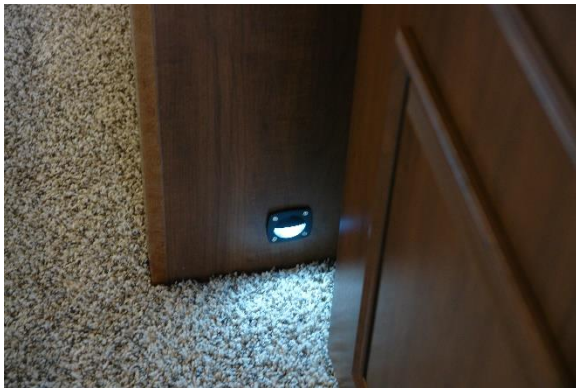

Welcome Back Light

When you open the main entrance door, a switch under the door frame activates the Welcome Back Light feature, turning on the ceiling entry light over the doorway. This allows you to enter the coach, and turn on other lights without fumbling in the dark. The light goes out automatically after a pre-programmed interval. The Welcome Back Feature is disabled when the Entry Light switch is turned ON.

M-Plex Master Off Switch

The M-Plex Master Off switch turns off all interior coach lights (except floor-level night lights). This allows you to turn everything off with one button when leaving the coach. Some coaches have another M-Plex Master Off switch located in the bedroom so all lights can be turned off with a single button press when retiring for the night.

Tank Gauges



Pressing the Systems Monitor changes the display to show the water level in each holding tank. A 2nd press shows the approximate voltage level of the 12V DC power system. The Gauges give a very rough indication and can be affected by how level the coach sits, and other factors.

Water Heater Electric



The dual-mode water heater can be operated in electric-only mode, LP mode, or both at the same time.

The switch marked “12 Volt” uses 12 volt DC power from the batteries (when boon docking) or Power Converter (when on shore power) in conjunction with propane to heat the water with a flame. Note the small “DSI Fault” indicator above the water heater buttons. If this is illuminated, it means the Direct Spark Ignition on the water heater failed to light the burner after 3 tries.

The switch marked “120 Volt” uses 120 Volt AC (when plugged into shore power) to energize a heating element that raises the temperature of the water.

Checking for water in the water heater

Before turning the water heater ON, you must verify that there is water in the water heater tank. Normally, when RVs are winterized, and when shipped from the factory, the water heater is drained and the Bypass Control prevents water from entering the tank. Don’t assume that your dealer has set the water system to normal operation and filled the water heater tank for you.

The Bypass Control must be set back to the normal operating position and the tank filled prior to turning the water heater ON. If the 120 Volt switch is turned ON with an empty tank, you will quickly burn out the heating element.

If you’re not sure whether there is water in the tank, consult the [Water Heater Usage Guide](#).

Secondary Switch

On new trailers with Suburban Water Heaters, to protect you from accidentally applying power to the electric heating element, there is a secondary switch on the outside of the water heater. The exterior cover must be removed to access the switch, which is located in the lower left corner. There may be a cotter pin holding the switch in the OFF position. Atwood water heaters do not have this switch.

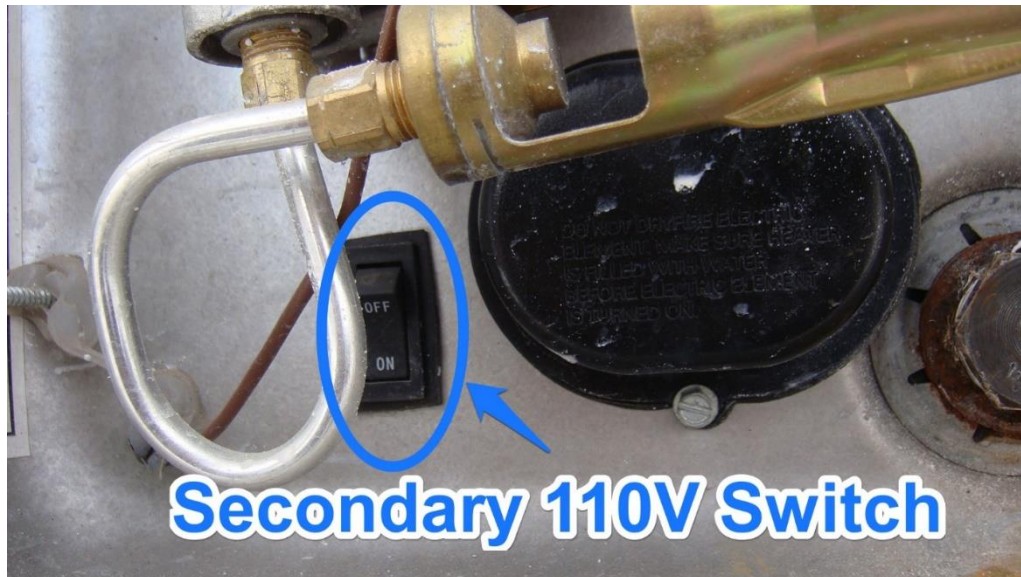

Water Heater Anode Rod

Suburban water heaters use a sacrificial anode rod to protect the tank lining from electrolytic damage. (Atwood uses a different tank liner material and doesn’t need an anode rod). Heartland ships the anode

rod uninstalled. The dealer should have installed it for you, but you should check that it's installed before connecting water the first time. Remove the outer cover of the water heater to check. The anode rod is a maintenance item that you should plan on replacing annually.

Water Heater Usage Guide

For more detailed information about your Water Heater, consult our owner-written [Water Heater Usage Guide](#).

Water Heater 12 Volt / Propane Operation

Turning the 12 Volt Water Heater switch ON should start the propane side of the heater as long as propane is flowing and your batteries/power converter are providing approximately 12V DC.

Once the switch is turned ON, during the next 15 seconds, the control board will attempt to purge air from the propane feed line and will attempt to light the propane burner 3 times. If it fails, the water heater will lock the LP operation for safety reasons and the DSI Fault Light above the water heater buttons will be illuminated. Note that if the water in the tank is already heated, the ignition sequence may not occur until the water cools a bit.

Yeti Package - Tank Heaters and Heat Tape

The optional YETI package includes 120V AC powered tank heating pads on each holding tank along with 12V DC powered heat tape on the portion of the fresh water feed line in the underbelly. One switch turns on all the tank heating pads. The other switch turns on the heat tape so that the water line from fresh tank to the pump doesn't freeze.



In sub-freezing weather, if the heat tape is not turned on before temperatures drop, you may have ice at the junction where the fresh tank drain hose is teed into the feed line. The water above the drain valve, and below the coroplast is first to freeze and ice can wick up into the tee fitting, blocking water flow.

Caution: you must have a few gallons of water in the holding tanks when the tank heaters are turned on. Heating empty tanks may result in damage to the tank.

While heat tape is designed to keep water in the line from freezing, once there's a block of solid ice, it could take quite a while to thaw. If this happens, using a hair dryer on the fresh tank drain hose may speed up thawing the line.

Ceiling Fan

The control panel switch turns the interior 120V AC powered ceiling fan on (if so equipped). There may also be a pull chain on the fan to control the speed. Repeatedly pulling the chain will cycle it through the various speed settings and OFF. There may also be a switch on the fan to reverse direction. In warm weather, set the fan to rotate so that air is pushed down. In cool weather, set the fan to rotate so air is pulled up. As the fan turns, if the leading edge of the fan blade is higher, air will be pushed down. If the leading edge is lower, air will be pulled up.

Miscellaneous Controls

Water Pump Switch



The Water Pump switch provides power to the water pump for times when the coach is not connected to city water. The water pump pulls water from the fresh water holding tank and pumps it through the plumbing using the same lines that city water follows. The pump has a pressure sensor that detects the drop in pressure that occurs when a faucet is opened. If the pump has 12V DC power, when the

pressure drops, the pump begins pumping water. When you close the faucet, pumping continues for a short time until the pressure sensor detects that normal pressure has been restored in the lines.

Note that when using fresh tank water, in addition to having the pump turned ON, the 4-way Anderson Valve in the Universal Docking Center (UDC) must be set to NORMAL. This setting enables water from the fresh tank to flow through the 4-way valve to the faucets and other fixtures. If not in NORMAL mode, the pump will run for a short time but no water will come through the faucets. Note that on newer Anderson Valves, the CITY setting also allows water to flow through the pump.

CAUTION: If you hear the water pump running when faucets are closed, it's critical to find the cause without delay. While it could be due to a malfunctioning pressure switch, it's more likely there is a water leak somewhere in the plumbing system. If not corrected, water leaks can lead to extensive damage. If you are unable to resolve the problem, the pump switch should be turned OFF to prevent damage to your coach.

When using city water, it's a good practice to leave the Water Pump switch OFF. It's also a good practice to leave the switch OFF when towing and when leaving the coach for long periods.

Note that pets have been known to jump onto kitchen counters and rub against the faucet controls, turning water on. If you leave the pump turned on with gray tank valves closed, you could return to find the interior of your RV flooded.

Awning Switches



The Awning switch extends or retracts the main patio awning. The Awning Light switch turns on the LED strip mounted on the coach sidewall, along the awning. If your coach has an optional exterior TV, a separate patio awning is provided for the TV area outside the coach. A separate awning switch for the TV awning is usually located inside, near the entrance door.

Awning Receptacle Switch

The Awning Receptacle switch turns on 120V AC power to an exterior outlet located near the front of the main awning. This allows you to hang lights on the awning or nearby and turn them on and off without going outside.

Inverter Remote Switch



When towing, your batteries supply power to an inverter that converts 12V DC into 120V AC to power the Residential Refrigerator. Any time that 12V power is turned off, either by removing batteries for service or when in storage, or by turning the battery cutoff switch(es) to OFF, the inverter will turn off and stay off when power is reconnected. The remote switch may be used to turn the inverter ON, provided the battery cutoff switches are ON.

Some owners have asked about leaving the inverter ON when camping and connected to shore power. This is an acceptable practice and provides protection in case the power goes out in the campground.

When preparing to leave on a trip, after shore power is disconnected, it's a good practice to check the light on the Inverter Remote Switch to ensure that the inverter is ON. Also check that the refrigerator is ON.

Inverter Status Indicator Light Modification

Some owners have installed a simple modification to their coaches in order to monitor inverter status while towing. They have installed a bright green or yellow LED light on the front wall of the trailer, under the pin box overhang. The LED is powered from the inverter's spare 120V AC outlet using a 120V AC to 12V DC adapter. When towing, every time the driver looks in the left side mirror, the LED will confirm that the inverter is supplying power to the refrigerator.

[Here's a link to a detailed description of this modification.](#)

Pass-thru Storage Lights and Front Storage Compartment Light

The pass through basement storage has several lights on the front wall with individual on/off switches on each light. In addition, there is a master on/off switch next to the Auto Leveling control panel. If the individual light switches are ON, you can operate both lights by using the switch next to the control panel.

There is also a light inside the front compartment, with an on/off switch inside the compartment, on the right side.

Appliances

Cooktop

Early Landmark 365 units came with an induction cooktop. The mid-year 2017 models changed over to the Furrion residential type gas cooktop and gas oven.

Residential Refrigerator

The residential refrigerator is 120V AC only. Because it has been designed for use in residences, it does not run on propane as RV gas absorption refrigerators do. A continuous supply of 120V AC is required for proper operation.

In order to provide 120V while towing, there is an inverter to convert 12V DC from the batteries into 120V AC for the refrigerator. This is described in more detail below.

In your sticks and bricks home, it's generally not necessary to winterize the refrigerator. However, before storing the RV for the winter, it is critical to properly winterize the refrigerator in your RV. This includes components inside the refrigerator and outside the refrigerator. Detailed instructions may be found in our [Residential Refrigerator User Guide](#). Note that Heartland changes refrigerator models and suppliers over time, so the guide may not reflect the actual location of controls inside your refrigerator.

Even if you're living in the RV all year round, if temperatures are forecast to drop below freezing, you'll need to winterize the water feed line that supplies the refrigerator (if so equipped). There are parts of the line, and a drain valve, exposed to outside air. The poly line and drain valve may be damaged in a freeze. Refer to the [Residential Refrigerator Guide](#) for instructions on winterizing the water feed line.

Refrigerator Water Feed Line Cutoff Valve

The water feed line that supplies the ice maker has a cutoff valve inside the coach. On most floor plans, it will be located either under the sink, or under and behind the bottom drawer to the left of the sink.



Overview of electrical and inverter

The batteries are connected to an inverter that changes 12V DC into 120V AC. The inverter output goes to an automatic transfer switch (some inverters may have a built-in transfer switch). When connected to shore power, the transfer switch routes shore power to the refrigerator. When shore power is disconnected, the transfer switch routes the inverter output to the refrigerator.

In order to conserve battery power when not using the coach, both the refrigerator and the inverter should be turned off. The inverter can be turned off using the remote button in the control panel, or by operating the Inverter Battery Power CUTOFF switch in the front storage area. The pictures below shows the cutoff switches that are in the front compartment and the inverter remote button that is inside the coach.

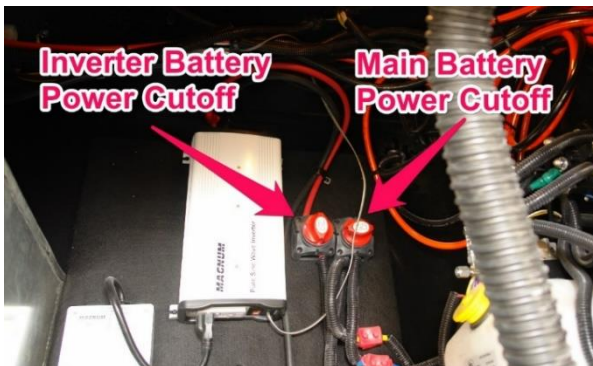

NOTE: After switching the battery cutoff switch ON, you must manually restart the inverter or the refrigerator will not receive any power from the batteries. If you are plugged into shore power while loading up for a trip, the refrigerator will run on 110V shore power. But if you forget to turn on the inverter, when you begin towing, the refrigerator will not receive power.

Refrigerator Outside Access Panel

In late 2016, Heartland added an outside access panel behind the refrigerator, allowing access to the water line connections without moving the refrigerator. (Shout out to Paul Townsend for pictures)



Microwave/Convection Oven

Beginning with the mid-year 2017 changes, the Furrion Convection/Microwave Oven began shipping with Landmark 365.



Vent

The exterior vent cover needs to be opened before cooking so that hot air can be vented from the microwave/convection oven. You'll probably need a step ladder to reach the vent.

CAUTION: Microwave/Convection ovens usually have over-temperature sensors used as a safety feature to interrupt power if the interior of the oven overheats. Once triggered, these sensors have to be replaced, which may require help from a technician trained on ovens. Using the oven with the vent closed could cause overheating that causes a safety shutdown.

Looking up on the exterior wall of the coach, you'll see two tabs on the bottom corners of the vent. To release the vent, push up on both tabs at the same time and as they release, pivot the bottom edge of the vent cover outward. The vent cover tabs are often quite stiff and may require quite a bit of force to release the cover.



Photo by JohnD

Most owners leave the vent open while traveling. During storage, it's probably a good idea to close it.

General Usage Notes

Microwave/Convection ovens can typically be used either as microwave oven, or as a convection oven (where the hot air is circulated to reduce cooking time), or on some ovens, in a combination mode to speed cooking even further.

On many convection ovens, temperature settings may not be quite the same as with conventional gas or electric ovens. Recipes often must be adapted slightly to convection ovens.

If this is your first experience with convection oven cooking, you may find it helpful to consult a cookbook devoted to convection oven cooking.

Washer/Dryer

The washers and dryers made for RVs are typically smaller capacity units than those found in most homes. You'll find that the RV washer and dryer work better with half-size loads.

RV dryers are supplied with 120V AC whereas home dryers are usually 240V. The additional power allows the home dryer to dry a load of clothes much quicker. RV dryers take longer.

Consult the washer and dryer manuals that came with your RV for specific operating instructions.

Before storing the RV for the winter, you will have to take several specific steps to winterize the washer correctly. See our owner-written [Winterization Guide](#) for directions on winterizing the washing machine and protecting the water lines and drain.

If you have washer/dryer prep, but do not have the washer, you still need to winterize those water lines.

Dishwasher

Consult your dishwasher manual for operating instructions.

Winterizing the Dishwasher

The dishwasher should be winterized before storing the RV for the winter. Dishwashers drain systems will typically hold a little water at the end of a wash cycle. There may also be water in the drain hose because it tees into the drain line higher than the fitting on the dishwasher.

The example below uses a combination of compressed air and RV antifreeze to protect the dishwasher.

Use the instructions and pictures that follow to winterize the dishwasher. The drain line can be accessed at the rear of the dishwasher by opening the cabinet door.

1. Winterize the rest of the coach first. [Here's a link to our owner-written Winterizing Guide.](#)
2. Set your air compressor to 40 psi.
3. Press Power Button on Dishwasher to turn it on
4. Set Program Cycle to Heavy (or any cycle)
5. Shut Dishwasher door and dishwasher will start
6. Dishwasher will call for water. Most of the water in the coach lines will be gone. A bit of residual water may enter the dishwasher along with compressed air during the beginning of the wash cycle. Allow it to run for up to 3 minutes until you hear the dishwasher drain pump start and then stop
7. At the back of the dishwasher, place a towel below the drain line connection (lower left)
8. Grab a shallow bowl and a small dish/hand towel. Place the towel in the cabinet below the drain
9. Using hand-pressure only, remove the drain line and place the bowl below the drain to allow any water to be caught in it. Empty the bowl outside or in the toilet, then put it back in place under the drain. Leave the drain line disconnected
10. Press Power Button on Dishwasher to turn it off
11. Pour a cup of RV Antifreeze into the bottom center of the dishwasher
12. Repeat steps 3 through 6 and step 10. About a cup of liquid should empty from the dishwasher into the bowl. Much of it will be antifreeze. Pour this down the toilet bowl
13. Repeat steps 3 through 6 and step 10 again. This time, the liquid should be 100% antifreeze. Here again, pour that antifreeze into the toilet bowl
14. Press Power Button on Dishwasher to turn it off
15. Reconnect the drain line – hand tighten



Plumbing

Universal Docking Center (UDC)

Anderson 4-way valve

The Anderson 4-way valve simplifies water hookups. The four positions on the selector allow you to select the various functions without changing the water hose connection.

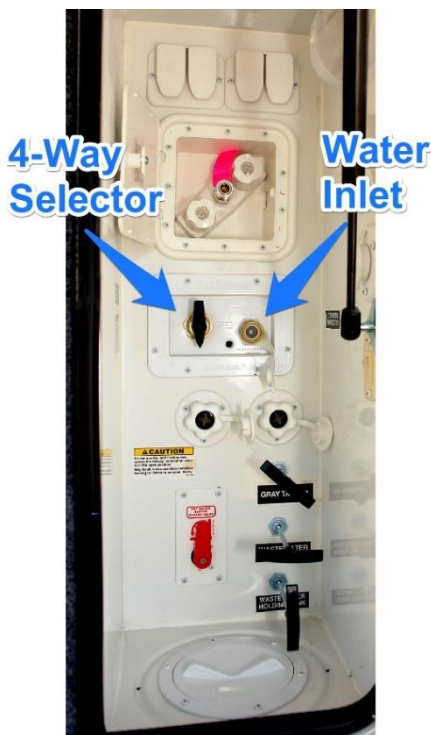

City

When connected to a campground water faucet, the selector should be on City. This allows the campground water to flow directly to your water faucets, shower, and toilet. On the City setting, a

channel is also open to allow water to be pumped from the fresh tank when the pump is turned on. This allows you to use the pump at rest stops without having to change the setting of the 4-way valve.

Normal

Anderson uses the term “Normal” to describe using the water in the fresh water holding tank in conjunction with the water pump to deliver water to your faucets. Setting the selector to Normal connects the fresh tank feed line to the water pump input. The pump must also be turned ON.

Sanitize/Winterize

When set to Sanitize/Winterize, the hose connected to the Anderson Valve water inlet will feed incoming fluids to the input (suction) side of the water pump. If the water pump is turned on, it will suck fluid from the hose, through the pump, and out to the faucets, shower, toilet, washing machine, outside shower.

To sanitize, you can disconnect your city water hose and fill it with a bleach solution as directed in your Heartland Trailer Manual (1/4 cup of bleach to 1 gallon of water). Then connect it to the water inlet and use the pump to suck the mixture through the water lines to the faucets, etc.

To sanitize the fresh water tank, you’ll need to use the same technique with the selector set to Tank. Use city water to push the bleach solution into the fresh tank.

When sanitizing, refer to your Heartland Trailer Manual for additional steps.

For winterizing instructions, refer to the [Winterization Guide](#).

Tank

To fill the fresh water holding tank, set the selector to Tank and with hose connected, turn on the campground water faucet. The fresh water holding tank has overflow hoses. When the tank is full, water will come out of the overflows on each side of the frame.

Black Tank Flush Connection(s)

There is a separate water inlet connection for the black tank flush. And if your RV has a 2nd bathroom, there is a second connection to flush that black tank.



The black tank flush allows you to run campground water through a sprayer mounted inside the black tank in order to help clean out the tank.

Safe Practices

It's a good practice to use a different, clearly marked hose for the black tank flush. Although the routing of the black tank flush water lines, and the use of a vacuum breaker valve, will help prevent contamination of the water hose, it's a good practice to use a different hose to provide additional protection against contamination in the event of a valve failure. Some owners add an additional check valve to the Black Tank Flush Inlet to provide further protection against contaminating hoses or the campground faucet.

Whenever water is running through the Black Tank Flush, you should either have the black tank gate valve in the open position, or if the gate valve is closed, you should take great care to avoid overfilling the tank. Using the timer function on your smart phone is one way to keep track of how much water is being added to the black tank through the flush system. If you assume water flow of 5 gallons per

CAUTION: Overfilling the black tank can create a huge mess inside the RV and could damage the tank and/or plumbing connections. Do not allow yourself to be distracted while operating the Black Tank Flush. It's also a good idea to notify other parties using the trailer that you are dumping the tanks, so they know not to use the toilet. If the tank is overfilled, there will be upward pressure on the toilet, sewage may rise into the vent that goes to the roof and could pour out on the roof and run down the sides of the RV. Sewage can also escape into the underbelly if tank connections are forced apart by the internal pressure. Using a timer will help avoid these scenarios.

minute, setting a timer for 6 minutes will add about 30 gallons to the black tank. If you've emptied the tank and are filling it with the Black Tank Flush to facilitate a 2nd emptying, 30 gallons should be enough.

If your floor plan has a 2nd bathroom, there will be a separate black tank for that bathroom, along with a separate Black Tank Flush Inlet for that tank.

Tank Valve Handles

In a single bathroom floor plan, the holding tank gate valve pull handles are located in the UDC. The bottom handle is for the Black tank. The middle handle is for Gray #2, which is the galley. The top handle is for Gray #1, which collects water from the bathroom sink and shower, and the washing machine.



In floor plans with a 2nd bath, the pull handles are arranged differently. Gray #1 is still on top. The middle and bottom pull handles are for the two black tanks. The bottom pull handle is for the main bathroom black tank. The middle handle is for the 2nd bathroom black tank.

In floor plans with a 2nd bath, the pull handle for Gray #2 has been relocated and is inside a compartment door near the UDC.



For additional information along with tips and techniques for keeping your holding tanks clean, consult our owner-written [Water Systems Guide](#).

Water Filter



Landmark 365 units come with a single-stage water filter located behind the Universal Docking Center (UDC). To gain access, you will need to remove the rear wall of the pass-through basement storage, next to the UDC. Many owners have modified that panel to allow easier access to the filter and water pump.

Most water filters that handle all water coming into the coach, as this one does, should be changed at least once every 6 months and perhaps every 3 months, depending on the quality of water coming into the coach. Particulates in the water supply at many campgrounds can clog the filter, reducing water flow. It's also important to change the filter to prevent bacterial buildup.

Water Filter Winterization

When winterizing the coach, the filter element should be removed from the canister before introducing antifreeze or compressed air.

Initial Installation

The water filter element is not installed in the canister when Heartland ships the RV to the dealer. While it's possible the dealer may have installed it for you, you should check. Since the dealer doesn't always know when or how soon you'll be using the coach, they may have left it to you to install.

Tips When Changing the Filter Element

First of all, turn off the campground water faucet and/or the water pump. Open a faucet in the coach to relieve pressure. Then use the canister tool to loosen the canister. Unscrew the canister. As it's pretty easy to spill water when opening the canister, placing a bucket underneath, or surrounding the canister with a trash bag while opening it will catch any water spills.

When closing the canister, make sure the rubber O-ring/gasket is placed correctly and is not pinched. Hand tighten until snug. Before replacing the pass-through storage wall, re-open the campground water faucet and/or turn on your water pump and check for leaks.

Water Pump



The water pump is located behind the UDC, on the floor below the water filter. When winterizing, the pump will suck antifreeze in and pump it through the water system (but not into the fresh tank or through the black tank flush systems). However, if using compressed air to winterize, you must take additional steps to protect the water pump and its filter assembly. Consult our [Winterization Guide](#) for details.

It's a good practice to check the fittings on the input and output of the pump periodically to ensure they're snug. Also check the clear filter bowl on the input side. They should all be hand tight.

Fresh Tank Fill

To fill the fresh water holding tank, the 4-way Anderson Valve must be set to TANK and you must connect a water source to the water inlet. As the tank reaches full capacity, the water will come out the overflow fittings on the outside of the frame. There is usually a pex line and 90 degree fitting that terminate on the door side, just to the rear of the entry steps. There may also be another drain on the off-door-side. The picture here shows where how the overflow comes out of the tank and through the frame. Additional PEX tubing is connected to route the water toward the middle of the coach.

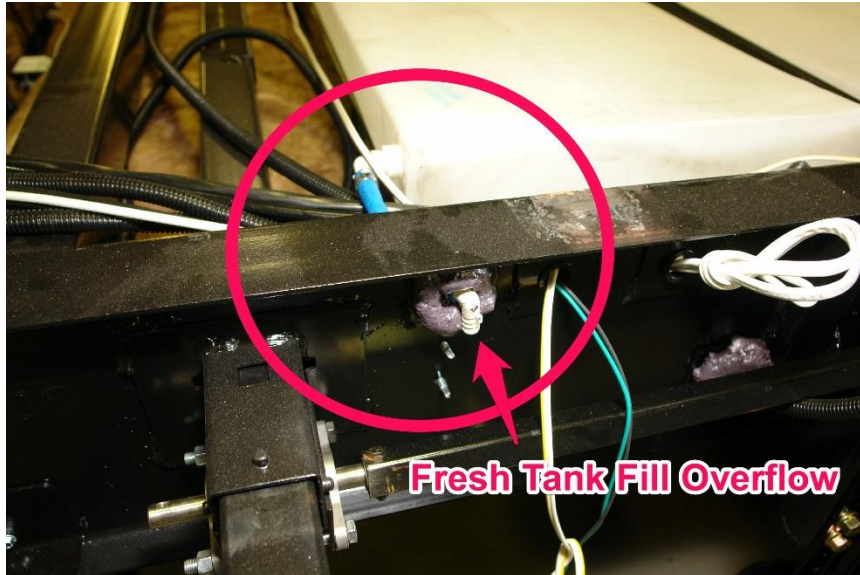

Fresh Tank Drain

The drain for the fresh water holding tank is located on the off-door-side, near the axles. There is typically an 8-12" length of pex sticking out from the coroplast, with a valve that is opened to drain the tank.

Filling the Fresh Tank From a Water Container

The city water inlet has a built-in check valve to prevent water from spurting out the inlet while using the water pump. A certain amount of water pressure is required to operate the check valve. Normally when hooked up to a faucet, the city/campground water supply provides enough pressure to operate the valve so that water will go through it.

If you are boon docking and want to add water to the fresh tank from a container, there probably won't be enough pressure to operate the check valve. Some owners have obtained inexpensive pumps to put in-between the water container and city water inlet. The pump will provide enough pressure to operate the check valve. If you're boon docking, a 12V DC pump will work without the use of a generator.

Low Point Drains

The Landmark 365 does not have low point drains. On trailers with low point drains, in cold weather, the water between coroplast and drain valve can freeze allowing ice to wick into the tee, blocking water flow. To avoid that problem, the Landmark 365 has no low point drains. There is still a fresh tank drain poking through the coroplast, on the off-door-side, near the front axle. There may also be an overflow drain for the washing machine.

Studor Air Admittance Valves

Sink drains have p-traps that hold a small amount of water to block sewer gas from entering the coach. When draining a sink, a vacuum effect can suck the water out of the p-trap. To prevent this, and to facilitate fast draining, the drain lines are typically vented through the roof. However, in some configurations, it's not practical to use a roof vent. A kitchen island may be one of those configurations.

To provide venting, a Studor Air-Admittance Valve is used. The vacuum effect causes the one-way valve to open, admitting air, which breaks the vacuum and prevents the water in the p-trap from being sucked out.

If the Studor Valve sticks open or fails altogether, sewer gas can enter the coach through the valve. Replacement valves are inexpensive and can be obtained at most big-box hardware stores.

While failure of the Studor Valve is not all that common, if you have a persistent sewer odor in the coach, you should check under the sink to see if a Studor Valve is present. Cover it with a plastic baggy secured by a rubber band. If the odor goes away, the valve should be replaced.



Heating and Cooling

Furnace

The furnace is controlled by one of the air conditioner thermostats inside the coach. While you may have up to three thermostats, with each thermostat controlling a separate air conditioning unit, only one of those thermostats is wired to control the furnace - usually the rearmost thermostat.

The thermostat will cycle the furnace on and off based on the ambient temperature at the location of that thermostat. Temperatures inside a 40 foot long RV usually differ by several degrees from front to rear. Also, warm air rises, so a front bedroom that's higher than the living room will always have more warm air than the rear of the coach. In addition, the furnace is usually located closer to the front of the coach, pushing hotter air through the ducts to the front bedroom and bath. By the time air goes the longer distance to the rear of the coach, it will not be as warm coming out of the rear floor registers.

You'll need to set the thermostat to provide a comfortable temperature in the part of the coach that you're using at any particular time.

If you have a fireplace or other supplemental electric heat in the rear of the coach, you may want to set the thermostat for comfort in the front bedroom and use the supplemental heat to keep the rear of the coach comfortable.

Furnace Air Return and Floor Registers

It's very important to never block the air return vents to the furnace. Doing so may cause intermittent operation of the furnace because there's not enough return air flow to allow the Sail Switch on the furnace to operate reliably. When the Sail Switch doesn't close, the furnace control board interprets this as a safety issue and prevents the furnace from operating.

While some owners have partially or completely blocked one or more floor registers, the furnace manufacturer strongly advises against doing so. Restricting airflow may result in overheating of the combustion chamber inside the furnace. There is an over temperature sensor in that chamber that will prevent the furnace from operating if temperatures get too high. The sensor could be weakened by repeated operation and result in a furnace malfunction where the blower runs continuously but the heat output is intermittent.

Air Conditioner Runs When Furnace Runs

If you turn on the furnace and the air conditioner blower starts running, along with the furnace, the fan setting on the thermostat needs to be changed to AUTO. If set on HIGH or LOW, the fan will run continuously any time the thermostat calls for either heating or cooling.

Air Conditioning

Each air conditioner has its own thermostat that turns on its respective unit based on the ambient temperature at the thermostat location. While the thermostats may be capable of supporting multiple zones, they are wired for single zone operation.

To minimize noise, you can adjust the thermostats so that the units furthest away from you are providing cooling through the common duct system. At night, turn the living area thermostats lower and the bedroom thermostat higher to minimize noise while sleeping. While watching TV downstairs, set the bedroom thermostat lower and the living area thermostats higher to minimize noise in the living area.

Air Conditioner Heat Pump Option

As an option, purchasers can select Air Conditioners that are also heat pumps. In essence, the unit can run in a way that extracts heat from outside and moves it inside when in Heat Pump Mode. Heat Pump Mode is selected on the thermostat. Note that in Heat Pump Mode, below about 30 degrees (F) outside temperature, the Heat Pump will shut off and the thermostat that is connected to the furnace will start the furnace.

Cleaning return filters



The ceiling registers for the air conditioning are aligned in two rows. The off-door-side registers supply cold air to the living area and bedroom, while the door-side registers are air returns with filters. The filters need to be cleaned frequently to maintain efficient operation of the air conditioners. If filters build up too much dirt, return airflow is restricted which can result in icing up of the air conditioner with loss of cooling. In the pictures above, the register on the right, with the dark material, is the return.

The register can be pried off with your fingers in order to reach the filter. It snaps back into place.

The register assembly has three parts: the register that directs the airflow, an interior fitting that holds the filter in place, and the filter itself. Once the assembly has been removed from the ceiling, the retaining tabs that hold the interior fitting can be pressed to release the fitting. Remove the fitting and take out the filter to wash it.





After washing, squeeze excess water from the cleaned filters and allow them to air-dry before re-installing.

What happens when available power is not enough

Three air conditioners may use up to 45 amps. If you are also running other devices such as the microwave/convection oven, water heater, etc. the Power Control System may take action to manage total power usage to fit available power. If so, power to one or more air conditioner compressors will be interrupted. The fan will continue to run.

12V DC Electrical

Fuse Box

The fuse box distributes 12V DC power to your internal devices and 12V lights, while also protecting those circuits with fast acting fuses. Note that some external devices, such as the hydraulic pump and electric brakes, do not receive power through the fuse box. Instead, the power to those devices is routed through 12V DC mini-circuit breakers located near the batteries.

The fuse box gets its power from two sources: The Power Converter (usually located behind the pass through storage rear wall) converts 120V AC shore power to 12V DC power that is routed to both the fuse box, and to the batteries for charging. The batteries also supply power to the fuse box to run the 12V devices when not plugged into shore power.

The inside of the fuse box cover is labeled to show what each fuse powers and protects.

The fuse box is usually located near the center of the coach, in the kitchen area, near the floor, but placement may vary by floor plan.

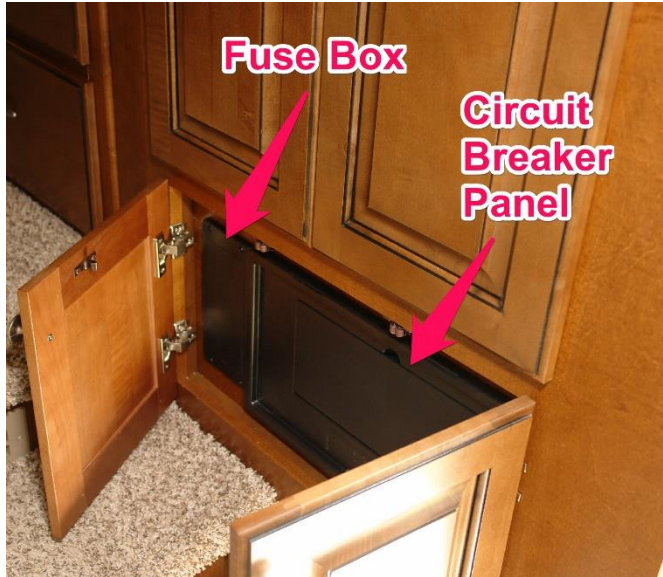

Checking for Blown Fuses

If a 12V DC device or wiring fails in such a way as to create a short circuit, the fuse for that device will blow. Each fuse has a metal strip inside that is designed to burn out if too much current flows through the fuse.

If a 12V DC device is not working, check the fuse that protects that circuit. If the metal strip inside the fuse is obviously burned out, replace the fuse. If the fuse looks ok, don't rely on the visual check. Test the fuse with an ohm meter.

If the new fuse blows immediately when you try to use the device on that circuit, further investigation will be required to determine why the fuses are blowing. If you aren't sure how to investigate, you'll want to contact your dealer or a qualified service shop.

Batteries

Because the Landmark 365 ships with a residential refrigerator, it also comes with two 12 volt batteries, wired in parallel. Wiring in parallel keeps the voltage at 12V DC while increasing the length of time the batteries can supply power. When not plugged into shore power, the batteries supply power to all 12V lights and other 12V devices. This includes circuit boards on the water heater, furnace, the auto-leveling system and hydraulic pump, motors for electric slide outs, the Power Control System, and 12V lighting.

Battery Cutoff Switches

There is one battery cutoff switch for general 12V operation, and a second one for the residential refrigerator power system. Cutoff switches are located in the front compartment.

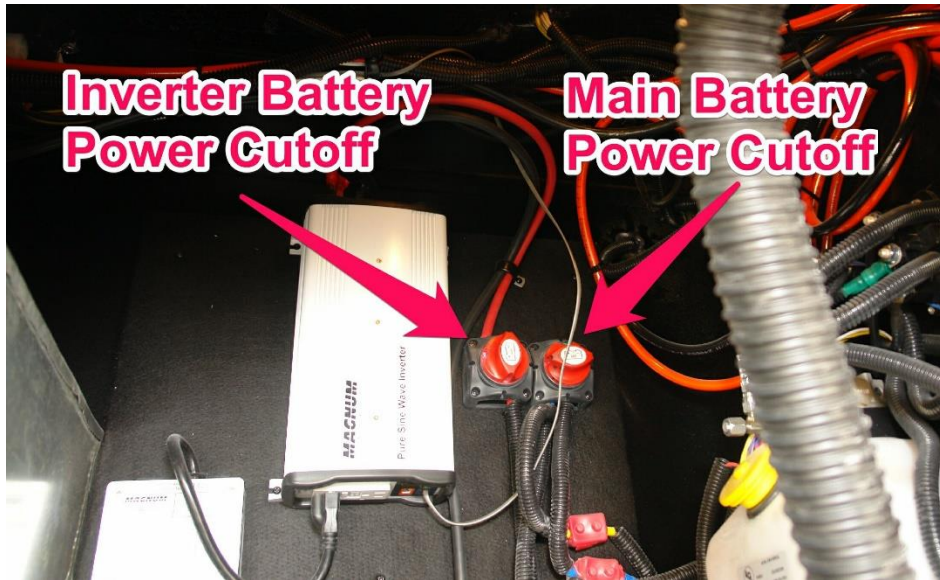

Keeping Batteries Charged While Storing the Trailer

If shore power is available at your storage site, keeping the trailer plugged in will keep the batteries charged by way of the Power Converter. The Power Converter monitors battery condition and adjusts its output accordingly. You can leave the trailer this way for an extended period, but it's a good practice to check the water level in the batteries monthly. If for any reason the water level drops below the top of the internal plates, a battery may be damaged and no longer perform adequately.

If there's no shore power available, to keep the batteries from discharging, both battery cutoff switches should be turned OFF. Batteries in good condition will generally hold a good charge for a month or longer. If the batteries are partially depleted when you return, connect the trailer electrical cord to the truck to slowly recharge.

Using an On-board Generator to Charge Batteries While in Storage

If you have an on-board generator, running it for 30-60 minutes monthly will keep your batteries topped off. However, if the batteries have been allowed to discharge significantly, there may not be enough charge left to start the generator. You may have to connect to the truck for 30-60 minutes to recharge enough to start the generator.

Restarting the Residential Refrigerator Power System

When the battery cutoff switches are returned to the ON position, you must manually restart the inverter that provides power to the refrigerator. This can be done either at the inverter, or inside the coach using the inverter remote On/Off switch. Additionally, if the refrigerator was turned off at its front panel, you'll need to turn it back on there as well.



Power Converter

The Power Converter converts 120V AC shore power into 12V DC power. Even if the batteries are discharged, or removed, the Power Converter should supply enough power to run your internal 12V devices and lights. There may not be enough power to run the hydraulics pump, slide rooms, or other high-current devices without having a good charge on the batteries.

The Power Converter is usually located in the area to the rear of the front basement pass-through storage. The rear wall of the storage area usually has to be removed to gain access. The Power Converter is plugged into a dedicated 20 Amp outlet that is on its own circuit breaker.

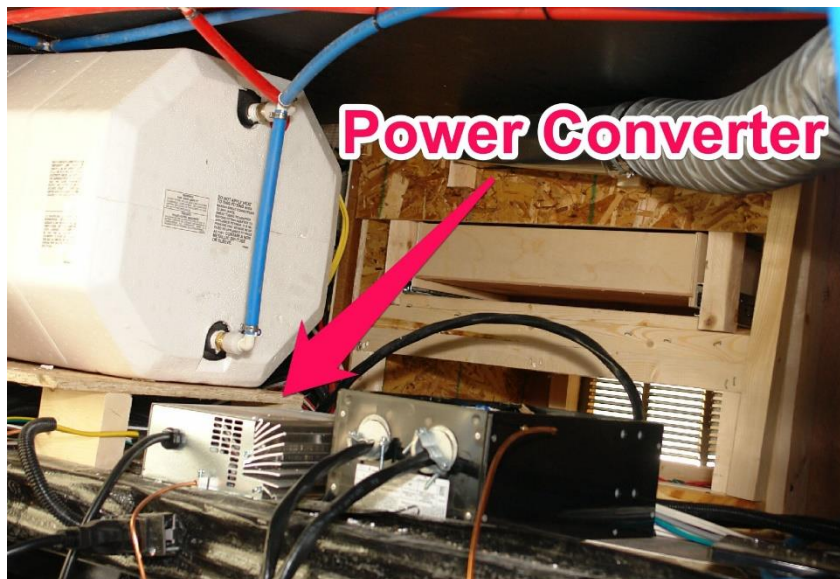

Buss Bar and 12V Mini-Circuit Breakers

The high-current devices such as the hydraulics pump and slide out motors don't receive power through the fuse box. There is a buss bar with 12V DC mini-circuit breakers, located near the batteries, which

supplies power to those devices. The batteries supply power to the buss bar, which is a copper plate to which each circuit breaker is connected. One of the circuit breakers connects the buss bar to the Power Converter and fuse box circuitry. Here's an example of a buss bar and circuit breakers.

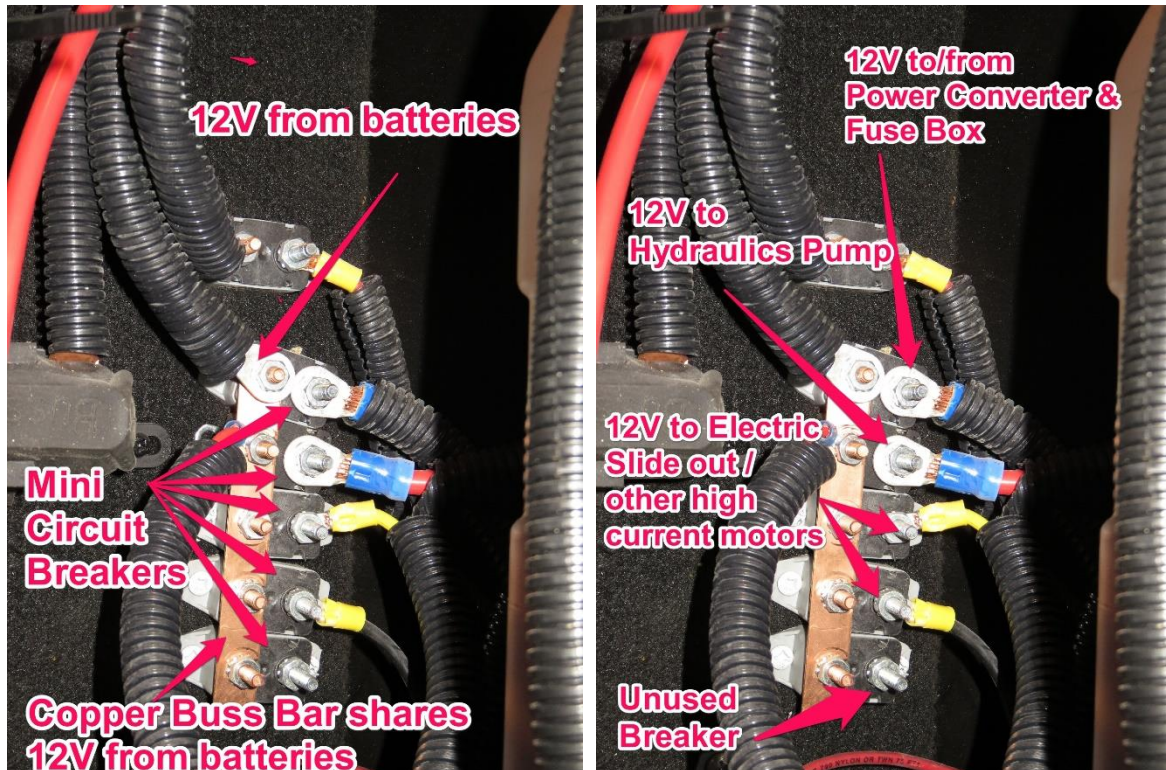

Your buss bar and breakers will likely be covered by a red rubber boot and the arrangement and number of breakers may differ from this example.

Notice that power comes in on the heavy red wire attached on the top left of the buss bar. Each of the breakers receives power from the copper plate. Of the 5 breakers on the buss bar, the top-most breaker, where battery power is attached, has a matching heavy wire on the right. That wire generally goes to the fuse box and Power Converter. That breaker is usually a 50 amp manual-reset breaker. If it trips, the batteries will not supply power to the fuse box, and the Power Converter cannot supply power to the batteries to keep them charged. There is a teeny-tiny reset button on the left edge of the breaker.



The other circuit breakers are auto-reset. They may trip if the device being powered draws more amps than the breaker is rated for, but will reset in a few seconds.

Hydraulics Pump Circuit Breaker

In the annotated buss bar picture, notice that the 2nd breaker from the top also has a heavy red wire attached to the right side of the breaker. That provides power to the hydraulic pump and auto-leveling system.

Intermittent Operation of Leveling System or Slide outs

If the operation of the hydraulic pump is interrupted for a few seconds while using the auto-leveling system or while operating hydraulic slide outs, the circuit breaker may be tripping and resetting. This can be caused by any of several things. Most commonly, the breaker has weakened and just needs to be replaced. The 12V 50 amp auto-reset mini-circuit breaker costs around \$10 and can be easily replaced in 10-15 minutes. Often, replacing the breaker will completely fix the problem.

Other possible causes include low battery charge or dirty/corroded battery connections, loose wires or loose crimps on the wires. These conditions lead to reduced voltage at the pump motor, causing the motor to draw more amps than the breaker is rated to handle.

There can be other possible causes, such as mechanical binds or motor issues, but these are far less common. Replacing the breaker may save you a trip to the repair shop.

Differences From These Pictures

It's possible that the hydraulics breaker could be on the top and the Power Converter/Fuse Box breaker could be the 2nd from the top. The main thing is to look for the size of the wires to find these two circuits. The breaker with the reset button is to the Power Converter/Fuse Box.

Power to Breakaway Switch and Generator Start

The emergency breakaway switch that activates the trailer brakes in the event the trailer were ever to break free of the tow vehicle must have power regardless of the state of the Battery Cutoff Switches. The same is true for the Generator Start. The main line 12V line between the battery and the main Battery Cutoff Switch has a small buss bar where the breakaway switch and generator start wires are attached.

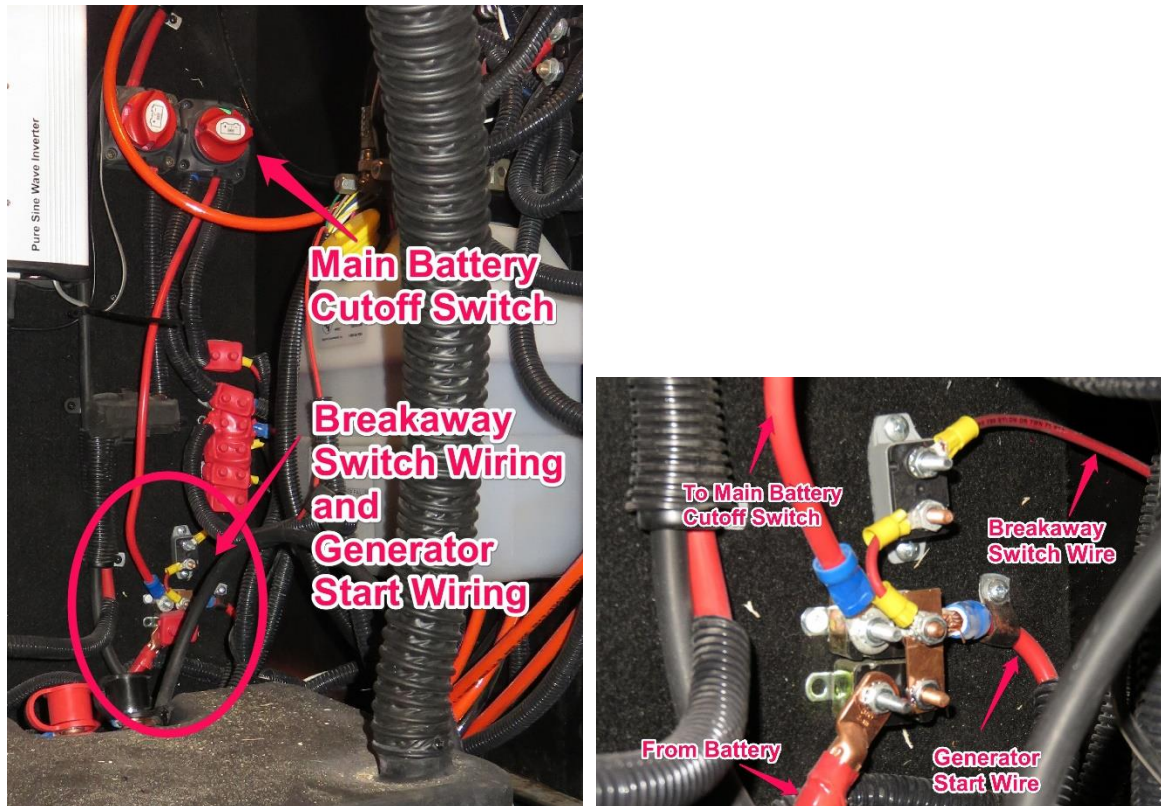

Residential Refrigerator Inverter

When towing, or when there is no shore power available, the residential refrigerator receives power from the coach batteries. The 12V DC battery output is sent to a dedicated inverter that converts the power to 120V AC. The inverter output goes to a transfer switch (the transfer switch may be either a separate unit, or it may be built into the inverter) that supplies power to the refrigerator. The inverter and transfer switch are dedicated to the refrigerator and do not provide power to anything else in the coach.

The inverter has a switch on one end, along with two 120V AC outlets. There is also a remote switch inside the coach that allows more convenient operation of the inverter.

If the inverter is ever turned off, or if the battery voltage falls below a critical level, or the battery cutoff switch for the inverter DC Power is turned off, the inverter must be manually restarted in order to run the refrigerator. When you bring the coach out of storage and plug it into shore power while loading up, the refrigerator will run on shore power. If you neglect to turn on the inverter before starting your trip,

as soon as you disconnect shore power, the refrigerator will shut down because there's no longer any power to it.

Our [Residential Refrigerator Guide](#) has additional information about the inverter and transfer switch, and the rest of the circuitry that provides power to the residential refrigerator.

120V AC Electrical

Circuit Breaker Panel

Devices that require 120V AC power receive that power by way of the circuit breaker panel. The shore power connector plugs into a campground power receptacle that provides two separate 120V 50 amp circuits for a total of 12,000 watts of power. Both of those lines come into the circuit breaker panel. A pair of 50 amp circuit breakers handle the incoming power from each of those lines and are tied together so as to operate as a single main breaker.

The rest of the breakers in the panel supply power to individual branch circuits/devices in the coach. The two incoming 50 amp lines supply alternating breakers from left to right in the panel.

When plugged into a 30 amp campground power receptacle, an adapter 'dog-bone' matches your 50 amp shore power connector to the 30 amp receptacle. The 30 amp receptacle has only a single line that provides power to both lines inside your circuit breaker panel. The 30 amp receptacle provides only 3,600 watts of power.

If you ever have a situation where some appliances work and others seem to have no power, it can be caused by one leg of the 50 amp campground power receptacle failing, or by a failure in the adapter when plugged into a 30 amp receptacle. Naturally, there can be other causes, but the campground power receptacle is a good place to start troubleshooting.

The circuit breaker panel is usually located near the center of the coach, in the kitchen area, near the floor. But placement may vary by floor plan.

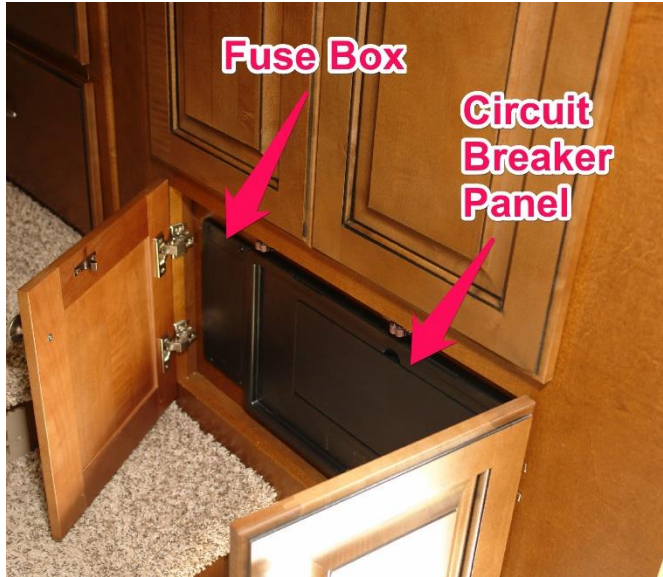

Generator Prep Automatic Transfer Switch and Surge Protector

The Landmark 365 ships with Generator Prep components including an automatic transfer switch that also has a built-in surge protector. The automatic transfer switch is separate from the one used in the residential refrigerator circuit. This transfer switch handles all incoming shore power. Its output goes to the circuit breaker panel. When an on-board generator is installed, the generator output is also connected to the automatic transfer switch.

When the generator is running, the transfer switch will use generator power, even if shore power is also available. When the generator is not running, the transfer switch will use shore power.

The transfer switch ensures that only one power source is powering the circuit breaker panel at any given time. It also ensures that generator power doesn't feed back into the campground power system.

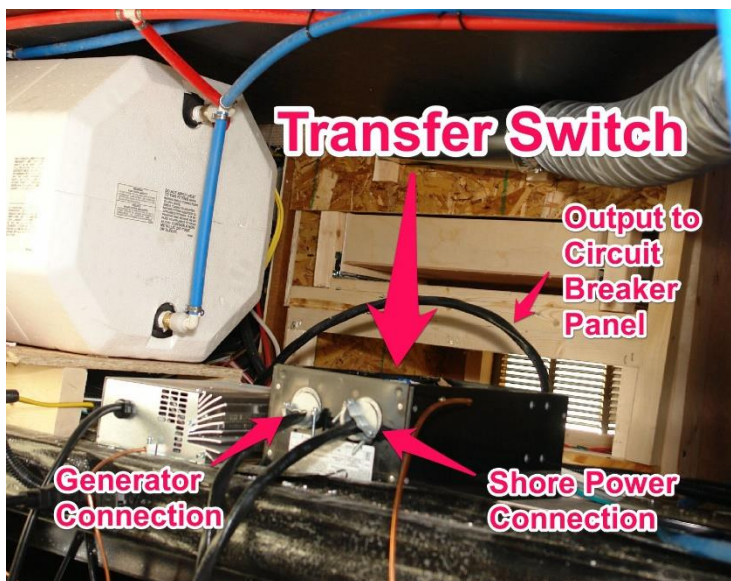

Built-in Surge Protector

While the surge protector built into the transfer switch guards against certain types of electrical problems, it doesn't provide the comprehensive protection of an Electrical Management System (EMS) such as the Progressive Industries EMS-HW50C device. You should consider adding an EMS to your coach.

Note: When power is connected or disconnected while there are appliances or other loads running in the RV, there may be arcing inside the transfer switch contacts. Over a long period of time, it's possible that this may cause pitting on the contacts, resulting in electrical issues. To prevent this arcing, before disconnecting shore power, or before turning the generator off, turn off the main 50 amp circuit breakers in the circuit breaker panel. Turn them on only after shore power has been connected or the generator has been running for about 30 seconds. Keep in mind that if you have an EMS device, they usually have a 2 minute delay before power is turned on. You should wait the 2 minutes before turning the circuit breakers back on.

While it's not essential to do this, it's a "best practice" that may save you from a repair a few years down the road.

Also, the campground power pedestal circuit breaker should be turned off before plugging or unplugging your shore power cable. This will avoid arcing on the prongs and possible damage to the campground pedestal.

Residential Refrigerator Automatic Transfer Switch

Because the Residential Refrigerator needs dual power sources, an automatic transfer switch is used to switch between shore power and battery power (via the inverter). Some inverters used in Landmark 365 units have built-in transfer switches. In those cases, there will not be an external transfer switch). The transfer switch receives power from one of the 120V circuit breakers in the main panel, and also is plugged into one of the outlets on the inverter located in your front compartment so it can receive inverter 120V AC power. The transfer switch ensures that only one power source is used at any time, and that you don't back feed power into the coach's power system.

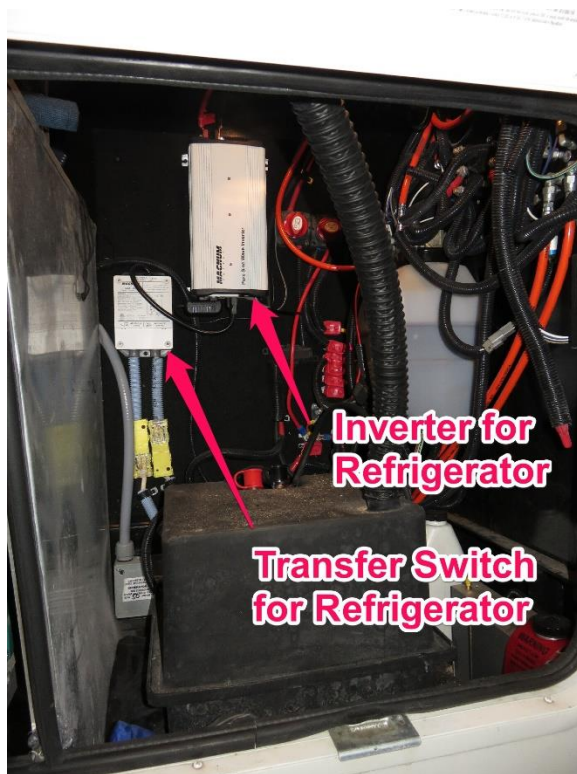

GFCI Outlet

For safety, outlets located near water sources (inside or outside) must be protected with a Ground Fault Outlet. This is usually located in the bathroom and can be identified by the test and reset buttons in the center of the outlet. If the GFCI circuitry detects a difference between the power flowing through the hot wire and the power flowing back through the neutral wire, it assumes that the leaking current is flowing through a human being and cuts power in a few milliseconds to protect you from injury.

If you ever have an outlet that is not working, the GFCI is the first thing to check. Press the reset button to try and restore power to the downstream outlet.

All outside outlets are downstream from (fed by) a GFCI outlet.

Surge Protection & Electrical Management Systems

Electrical Management Systems (EMS) protect against a number of common electrical problems including high voltage, low voltage, open neutral, incorrect frequency, and reversed polarity. Of these, low voltage is probably the most common problem RVs are likely to experience. In the summer, when every RV turns on one or more air conditioning units, campground power can be overwhelmed, and voltage can drop as a result. Wiring and equipment problems, especially in older parks, can also result in low voltage. Some of your devices can be damaged by low voltage.

An open or partially open neutral line from the power pedestal can wreak havoc on your coach's electrical devices resulting in thousands of dollars of damage.

An EMS device will protect you from damage. The two EMS leaders are TRC and Progressive Industries. They both sell EMS devices that can attach externally at the pedestal, or internally. Cost is about the same at \$350-400. As of this writing, the Progressive unit comes with a lifetime warranty.

EMS devices come in two models. There is a standalone version that plugs into the campground power receptacle. Your shore power cord then plugs into the EMS receptacle. There is also a version that can be wired in-line inside your coach. It can be placed either before or after the transfer switch. If it's placed after the transfer switch, the EMS will protect against external faults, and against internal faults up to and including a transfer switch fault.

Power Control System

The Power Control System automatically manages your electrical usage to fit within the amount of power available to the coach. Loads are shed as necessary to keep from tripping the inside main breakers, or the outside pedestal circuit breaker.

Description of Operation

The Controller measures the power across the two power legs coming into the circuit breaker panel (L1 and L2).

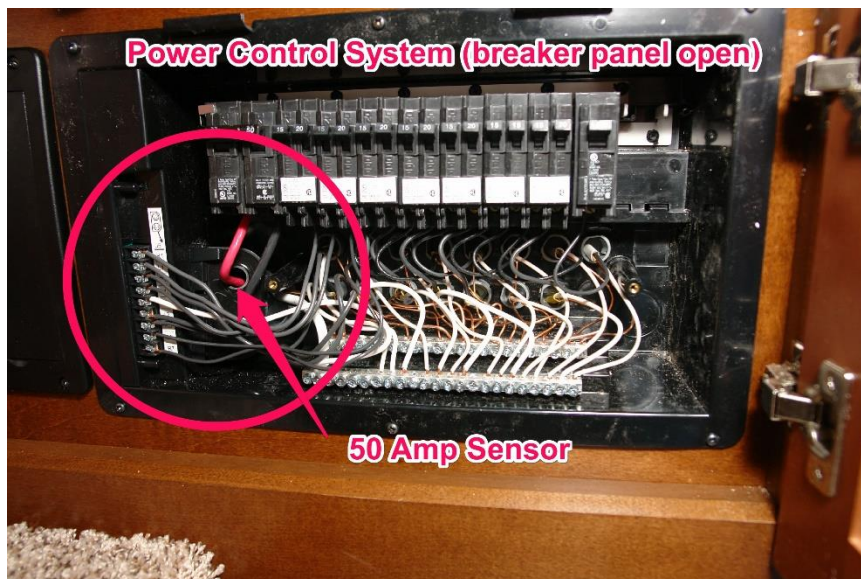

If it detects a voltage differential across L1 and L2, it interprets that as 50 amp service. If it does not detect a voltage differential, the system will assume that both legs are being supplied by a single source. In that case, the system defaults to a 30 amp setting. If plugged into a 20 amp circuit, you must set the controller to 20 amps manually. If you don't set it to 20 amps, the controller will operate as though the power source was 30 amps and you may experience power issues.

The system will automatically detect when the generator is running by way of connection to the generator hours meter.

When plugged into 50 amp service, L1 and L2 each get a separate 50 amps, so there is actually a total of 100 amps available, or 12,000 watts of power. When plugged into 30 amp service, only 3,600 watts are available.

Each of your electric appliances consumes a certain amount of power (watts) at startup and usually less when running. This is usually expressed in amps. For example, an air conditioner might take 15 amps at startup, and 13 amps when continuously running the compressor.

When running three air conditioners at the same time, along with other devices, such as the Microwave/Convection Oven, the Induction Cooktop, the Washer and Dryer, Water Heater, along with “hidden” loads like the Power Converter that supplies 12V DC power to the lights and batteries, you can exceed the power available from a 50 amp pedestal. The Power Control System will temporarily turn off power to some devices to manage total power consumption.

Reading the Precision Circuits Display

Each line on the display shows the name of the load (ex: Water Heater), whether that load is currently being supplied power by the Precision Circuits Controller (ON or OFF), and the number of amps the load was using the **last time the Controller turned that load OFF**.

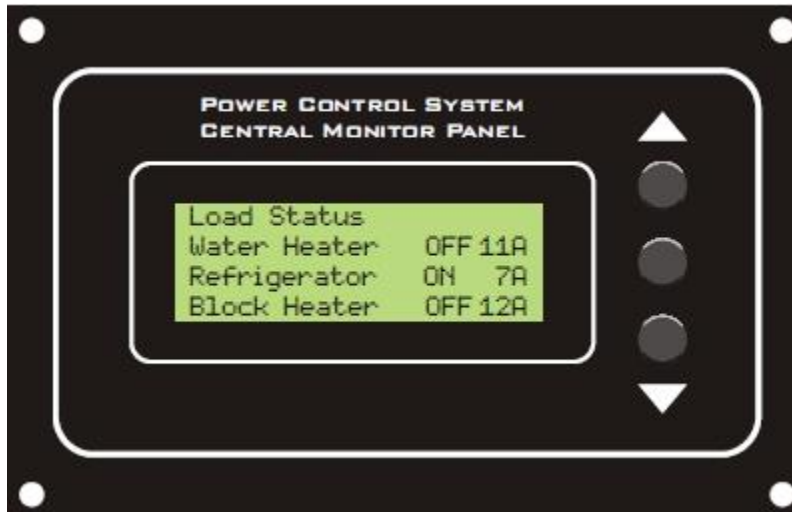

The refrigerator status in the picture above shows that it is currently ON. The last time it was shut OFF, it was using 7 amps.

Prioritization of Load Shedding

LOAD SHED TABLE																	
Relay #	Relay Type	Relay Voltage	Relay Connector	Line Assoc	Load Name (12 Characters Max)								Shed Order (1-7)				
Relay 1	120VAC 1	120VAC	J5-1,2	1	W	A	T	E	R		H	E	A	T	E	R	1
Relay 2	Air Cond 1	12VDC	J4-3,4,5	2	F	R	O	N	T		A	/	C				3
Relay 3	120VAC 2	120VAC	J5-3,4	1	M	I	C	R	O	W	A	V	E				7
Relay 4	Air Cond 2	12VDC	J4-8,9,10	1	M	I	D		A	/	C						5
Relay 5	120VAC 3	120VAC	J5-6,7	2	W	A	S	H	E	R	/	D	R	Y	E	R	4
Relay 6	Air Cond 3	12VDC	J4-6,11,12	1	R	E	A	R		A	/	C					2
Relay 7	120VAC 4	120VAC	J5-8,9	2	F	I	R	E	P	L	A	C	E				6

In the example table above, the left-most column shows the Power Control System relay number associated with each device. The fifth column from the left identifies which power leg that relay is associated with. The right-most column shows the order in which loads are shed. Water Heater is shed first. Rear A/C is shed second. Front A/C is shed third, and so on. Your coach setup may differ from this example.

Note that when the A/C loads are shed, the blowers continue to run, but the compressors are shut off.

Line Status

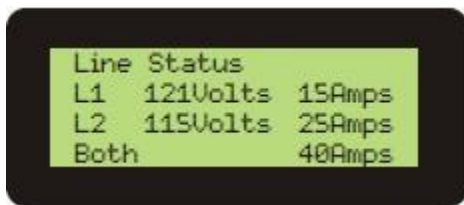

The line status display shows the number of amps currently being used on each leg of the incoming power.

KIB Multi-plex Control System

Power for 12V DC lights and other 12V devices generally originates in the main fuse box inside the coach. If any high current 12V DC devices, slides for example, are controlled, the power for those would typically come from the row of 12V DC mini-circuit breakers near the batteries.

Power for 120V AC devices comes from the main circuit breaker panel inside the coach.

Power from the fuses or circuit breakers is routed to the appropriate controller, where it is switched, and from there goes on to the devices. It may be useful to think of a standalone mechanical switch. Power would be routed from the fuse or circuit breaker to the switch and on to the device. With the KIB system, the switches are electronically controlled rather than being mechanical, and are activated indirectly by the actual switch panels when the switch sends a message to the controller.

The KIB Multi-plex Control System uses a combination of 12V DC and 120V AC power to switch lights and other devices on and off as described earlier in this document. The block diagram below depicts an overview of the electrical connections using a 12V DC and a 120V AC example.

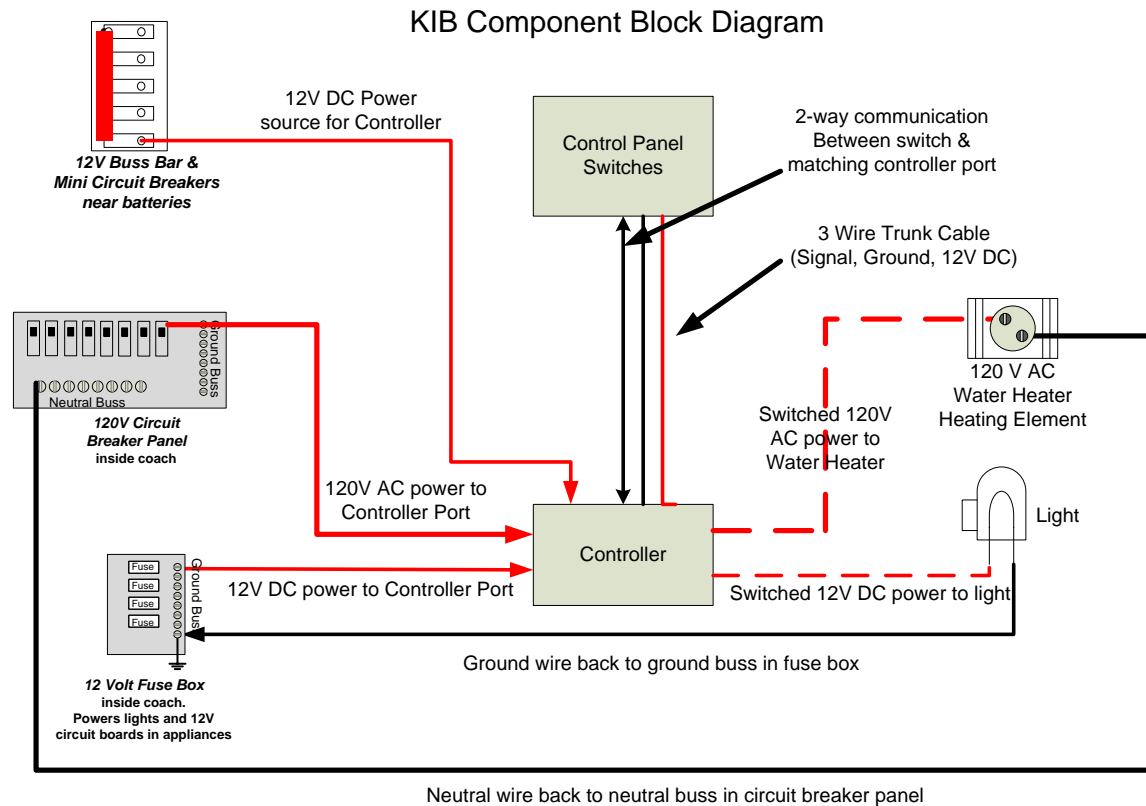

Entertainment Center

Watching Cable TV

Signal booster

The coax from the over-the-air antenna and the coax from the cable TV input are both fed into a signal booster usually located in a cabinet to the left of the bedroom TV, or in the front bedroom closet.



The signal booster amplifies the weak signals from the antenna and must be ON in order to receive over-the-air signals. However, when using cable TV, the signal booster must be OFF. It's important to set the signal booster correctly before attempting a channel scan on the TV.

Cable TV Set Top Boxes

In most campgrounds, in order to watch Cable TV, you simply connect the campground COAX to the Cable TV COAX connector in the UDC. Switch the Signal Booster OFF, and do a channel scan on the TV. But in some campgrounds, the connection may be more complicated.

In 2012, the major cable TV companies received permission from the FCC to discontinue analog TV service and provide only digital signals. In campgrounds where this change has been implemented by the cable company, customers must use a Set Top Box to decode the incoming signals. In campgrounds where a Set Top Box is required, a separate remote control changes channels on the Set Top Box, rather than changing channels at the TV. The output of the Set Top Box must be connected to the TV's input,

using available connections. Those connections may vary by Set Top Box and by TV. A coax connection to the TV's antenna input is typically available. Consult your TV manual for instructions on how to connect a Set Top Box to the TV.

Heartland provides several types of connections (COAX, AVI – R/W/Y, and HDMI) in the living room entertainment center to enable 3rd party devices to be patched into the TV without removing the TV from the wall. These connectors are pre-wired to the back of the TV. You can probably use one of them to connect the Set Top Box to the TV.

Watching Over-the-Air Antenna TV

The over-the-air antenna is located on the roof, toward the front of the coach. Directly under the antenna is a crank handle and rotation ring used to rotate the antenna for the best possible reception. Digital TV signals require good alignment of the antenna to the TV broadcast tower to get a clear picture. On digital TVs, if the signal is poor, you'll see pixilation and the picture may freeze momentarily.

Operating the antenna pointer

The antenna must be raised in order to effectively capture TV signals and in order to align it. Rotate the crank handle until the antenna is fully extended.

Grasp the outer ring of the pointer and pull it down slightly to disengage the outer ring from the inner ring, allowing it to be turned in either direction. Note that there is a pointer on the outer ring that indicates the direction the antenna is pointing. There's also a matching pointer on the inner ring.

When packing up to leave the campsite, be sure to rotate the outer ring until the pointers are aligned. Then rotate the crank handle to fully retract the antenna into a folded position on the roof.

CAUTION: If you forget to retract the antenna into its folded position, once you begin towing, the antenna will very likely be damaged. Some owners hang a visible reminder tag to the crank handle to help them remember.

TV Menu Settings

Most TVs made over the past few years have a menu setting to select between watching over-the-air antenna signals and watching cable TV. Consult your TV manual for information on how to make this selection and how to do a channel scan. Running a channel scan will allow the TV to identify all of the active channels so that you don't have to directly enter a channel number when changing channels.

A few newer TVs may automatically detect the type of signal source and switch automatically. Consult your TV manual for details.

Satellite TV

External Connections

Your Landmark 365 is wired so that you may use either a standalone satellite dish on a tripod, an auto-aiming dish in a small dome (carry-out) that sits on the ground, or a rooftop satellite dish.

The Universal Docking Center (UDC) has four satellite COAX connectors along the top of the UDC.



Of the two pairs of connectors, the right connector of each pair goes to the rooftop pre-wiring. The left goes to the living room or bedroom. If you have a rooftop installation, the rooftop connector must be jumpered to the living room or bedroom connector. The drawing below provides additional detail.

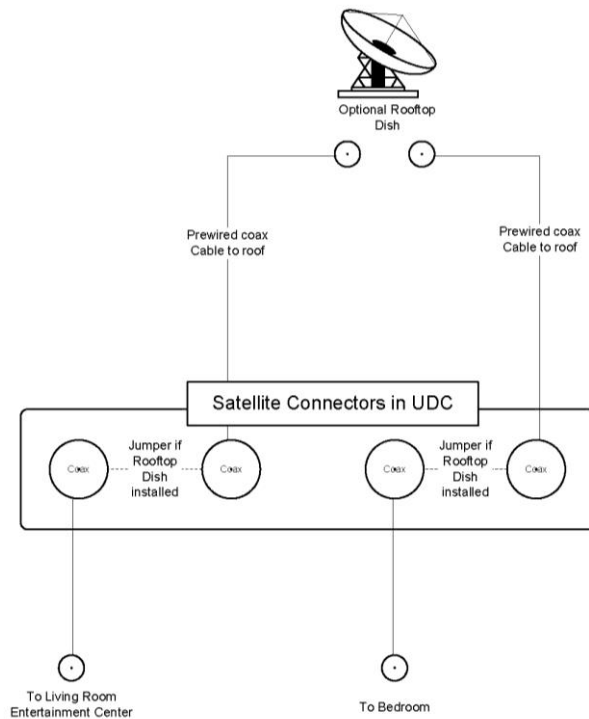

Internal Connections

The living room satellite connection comes out in the entertainment center.

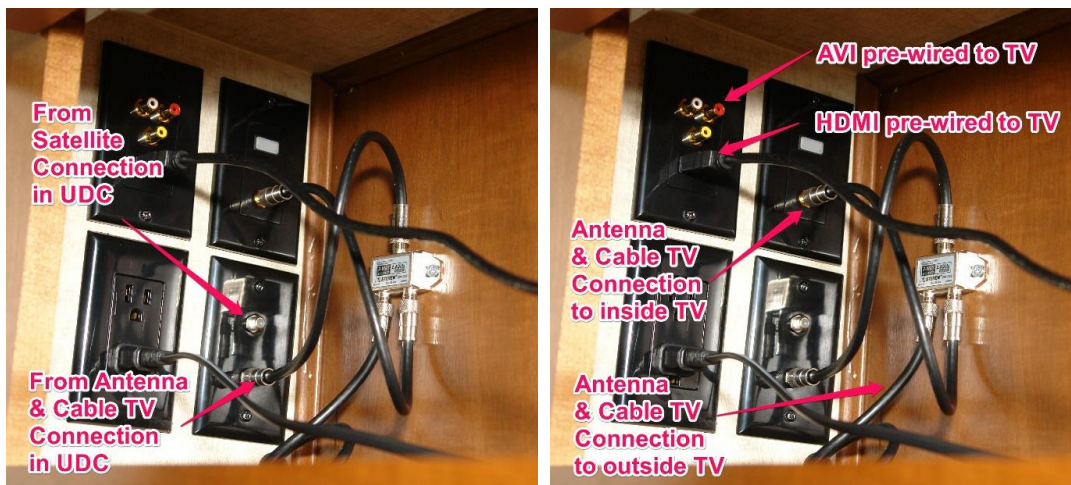

The satellite COAX connection would be wired to the input of your satellite receiver. The output of the satellite receiver would go to one of the open connectors on the wall plate. Newer receivers would probably use an HDMI output to the HDMI connector on the wall plate as shown above. Note that on occasion, the COAX connection positions may be reversed. If your coach doesn't have an outside TV, there may not be a wall plate for that location.

Rooftop Mount

Heartland prewires 2 coaxial cables from the UDC to the roof and a Winegard Trav'ler Control cable from the cabinet to the left of the bedroom TV (or bedroom closet) to the roof. The dish-end of the Winegard Trav'ler Control Cable and the dish-end of the two coax cables can both be found coiled in the roof under a blank white wall-plate in the ceiling of the bedroom (or bathroom in the Newport).

When installing a rooftop mounted satellite dish, you'll want to first remove the blank ceiling wall-plate and pull out the Winegard Trav'ler Control Cable and two coax cables. The installer would drill a hole in the roof to route those cables to the satellite dish. The installer will use the Winegard Cable Entry Plate to cover the hole/wire exit and will apply sealant around and over the plate.

In most professional installations, the installer will remove the rooftop satellite cables from the back of the wall-plates behind the UDC. Typically, only one of these is used. The installer will generally mount the satellite dish power inserter behind the utility wall. The coax from the rooftop antenna will connect to the coax input connector of the power inserter. The installer will generally mount the satellite splitter behind the utility wall. The input of the splitter will connect to the coax output connector of the power inserter. The installer will generally remove the bedroom and living room satellite cables from the back of the wall-plates behind the UDC. They will generally connect these feeds to two of the outputs of the satellite splitter.

A backer plate has been placed in the roof for the most secure fastening of the satellite dish. For the exact location on your floor plan, call Heartland Customer Service at 877-262-8032 / 574-262-8030. Have your VIN # ready. Many owners have installed a satellite dish on the roof without using the backing plate. But the best practice would be to locate it and install the dish to it.

Sound Bar and Subwoofer

Your Landmark 365 comes with a Sound Bar to produce higher quality audio output than television speakers can provide. It may come with a subwoofer to add to the listening experience. See the manual for your sound bar for specific operating instructions.

Landing Gear and Leveling System

Your Landmark 365 comes with Lippert 6 point Auto Leveling System. In most situations, after unhitching the trailer, a single button press will result in a perfectly level trailer.

It's also possible to manually level the trailer. This is particularly useful if you don't unhitch at a quick overnight stop. Lippert strongly advises against using the auto level function while hitched. The hydraulic system could damage your tow vehicle and your RV if auto leveled while hitched.

Control Panel Operation

Press the ON/OFF button to turn the control panel ON or OFF. The up and down arrow buttons on the left side allow you to cycle through the various functions of the controller. The ENTER button on the left is used to activate certain functions as directed on the control panel information screen. The RETRACT button in the lower left changes the manual operation of the landing gear. When first turned ON, pressing one of the FRONT/REAR/LEFT/RIGHT buttons will cause jacks to extend. If you press the RETRACT button, its LED will be illuminated, and then pressing a button will cause jacks to retract.

Notice around the FRONT/REAR/LEFT/RIGHT buttons that there are small LEDs. In manual operation, these lights will flash to indicate which one needs to be pressed to get more level. Of course the AUTO LEVEL button is used to start the auto leveling sequence. Always unhitch from the truck, and move the truck clear of the pin box before pressing the AUTO LEVEL button.

The front landing jacks operate together to raise the trailer for hitching/unhitching and to get the trailer level front-to-rear. The rear jacks operate as a left set and a right set. The center and rear jacks on each side operate together as a single unit.



Manual Leveling

To quickly level the trailer manually, cycle the control panel to MANUAL mode. Press and hold the FRONT button to extend the front landing gear. Let go of the button when the trailer is level front-to-rear. Then press and hold the REAR button until the rear and center jacks just slightly lift the frame. Because the trailer will already be level front-to-rear, you need only take a little weight off the tires. The trailer will then be primarily supported by the landing jacks. Finally, press the LEFT or RIGHT Arrow button to level side-to-side. The control panel will show a blinking LED to indicate which button to press. The display will show how level the trailer is as one side extends.

If you overshoot, by pressing the RETRACT button in the lower left of the panel, when pressing a button, the jacks will retract instead of extend.

If The Wheels are Lifted Off the Ground

Depending on how level the ground is, it's possible that in order to level the coach, the wheels on one side or the other could be slightly off the ground. While this may not be desirable for stability over the long term, in the short run it shouldn't be a problem.

Zero Level Calibration

The Auto Leveling System has a sensor that determines how level the coach is sitting. Whenever you use the AUTO LEVEL function, the coach returns to the reference position where the sensor is level. If the sensor position is ever disturbed, it will level to the new position, and the coach may no longer be level when that reference position is reached. The system can be calibrated by manually leveling the coach, and verifying how level it is with a carpenter's level, checked front-to-rear and side-to-side. Once the coach is level, pressing a specific sequence of key buttons will reprogram the system to recognize that as the new reference position for a level coach.

Because this sequence of key presses could change over time, you should refer to the Lippert manual that came with your coach, or call Heartland Customer Service at 877-262-8032 / 574-262-8030. Have your VIN # ready. They can provide you with the correct sequence. And of course, your dealer can also do a Zero Calibration Level set for you.

Manual Pump Operation

In the event of a control panel failure, or failure of the electrical components of the hydraulic system, the pump can be operated manually with a power drill, in conjunction with manually opening and closing the appropriate valves. You'll need a power drill with a 6" hex bit that is inserted into the end of the hydraulic pump. A 6" Phillips head driver bit mounted with the Phillips head in the drill will work. A set of Allen wrenches will allow you to manually open and close valves.

Because the valve locations and pump designs vary over time, you may have to call Lippert for specific instructions pertaining to your installation.

Revision History

04/19/2017 Initial release.